

主柱 S=1/3

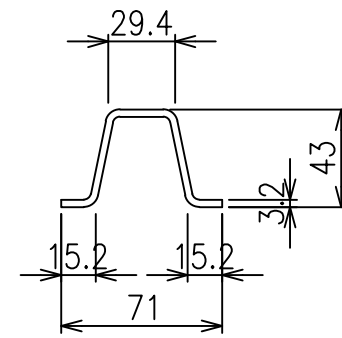

上胴縁 S=1/3

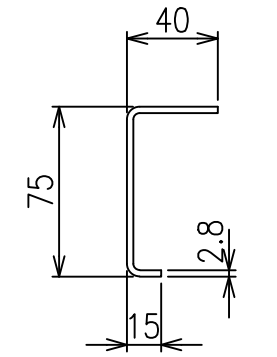

胴縁取付Uボルト S=1/5

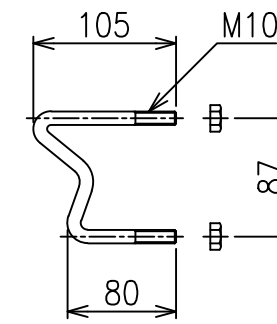

下胴縁 S=1/3

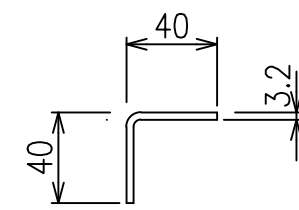

胴縁取付Uボルト S=1/5

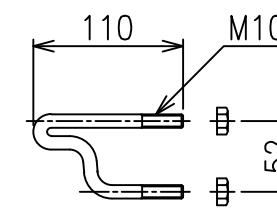

ボルト・ナット S=1/5

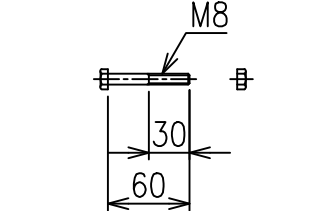

主柱胴縁取付部 S=1/6

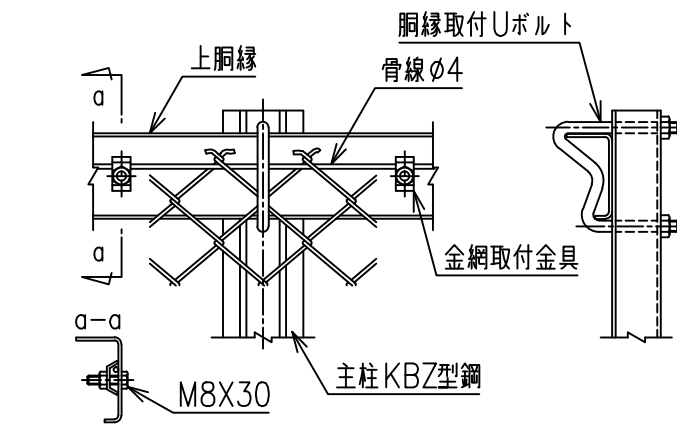

取付部詳細

主柱骨線取付部 S=1/6

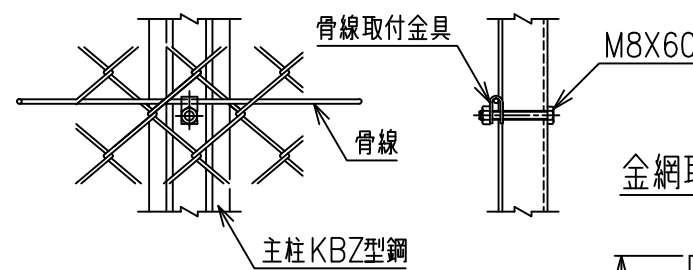

金網取付金具 S=1/2

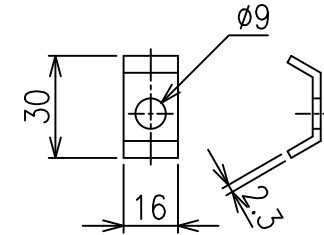

骨線取付金具 S=1/2

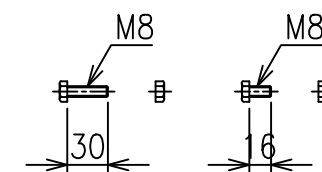
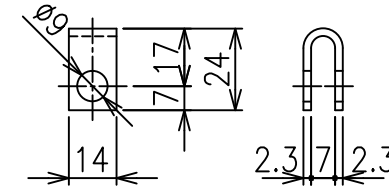

隅柱取付部 S=1/6

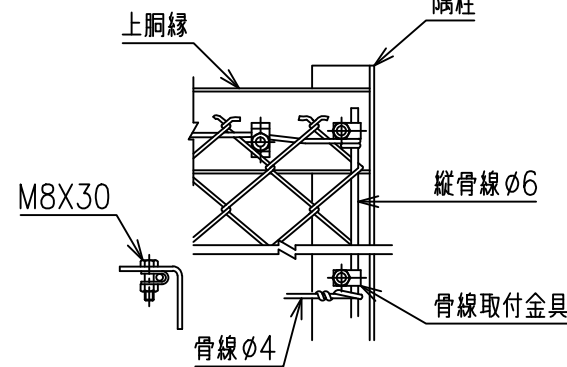

\*出力する用紙サイズにより、表示された縮尺とは異なる場合があります。