

主柱 S=1/3

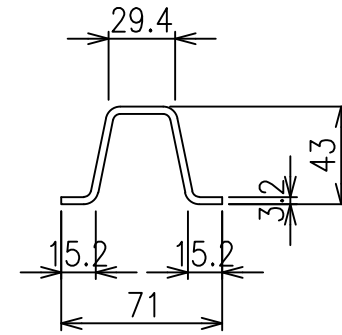

胴縁 S=1/3

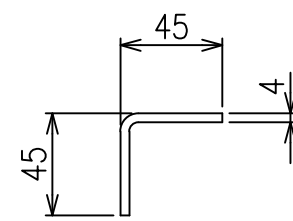

胴縁取付Uボルト S=1/5

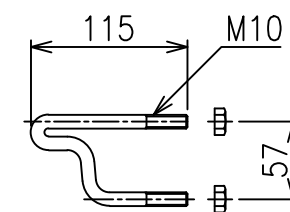

ボルト・ナット S=1/5

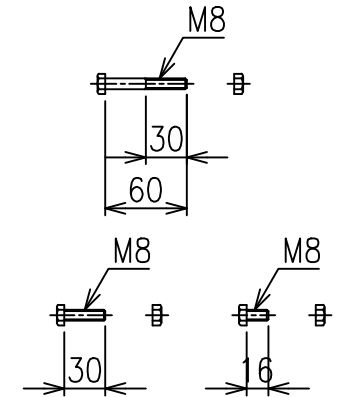

骨線取付金具 S=1/2

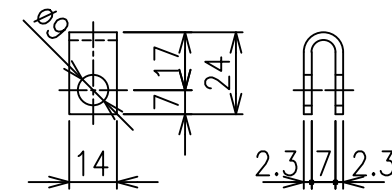

主柱胴縁取付部 S=1/6

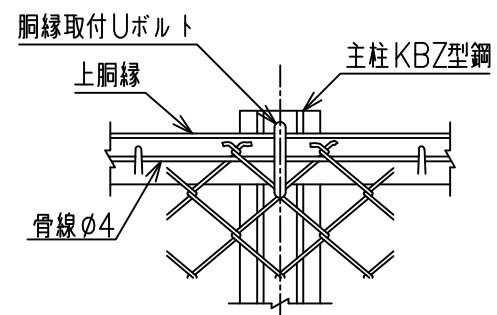

取付部詳細

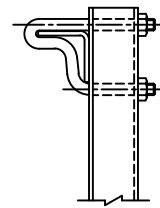

主柱骨線取付部 S=1/6

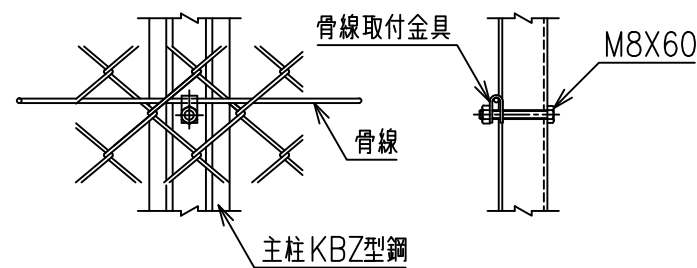

隅柱取付部 S=1/6

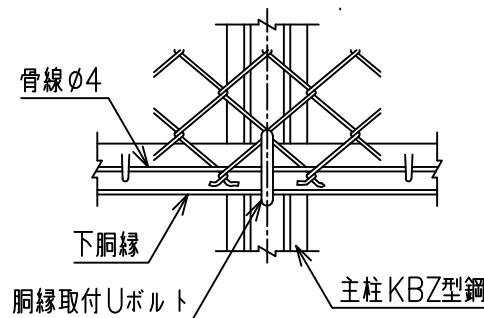
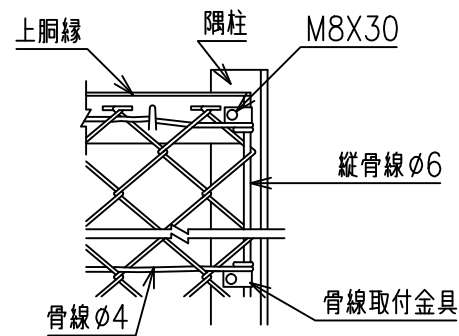

*出力する用紙サイズにより、表示された縮尺とは異なる場合があります。